

# sedus

Table programme

## temptation c



# Ergonomics start where functionality is achieved.

Movement plays an important role in health and therefore also in performance, which is especially true during working hours. This has been confirmed by recent studies which show how regularly changing one's posture can boost health. The Sedus *temptation c* height-adjustable table systems allow users to work both when standing and seated – precisely this active behaviour.





The customised setting of the seat height or seat/standing height, with height adjustment via either a gas spring or electric motor, guarantees the optimal height for working.

With electromotor height adjustment, the sitting/standing height can be conveniently set at the touch of a button (Fig. left), whereas the gas spring version enables independent adjustment and optimal load setting using a crank handle.



**Powerhouse.** Whether for daily work tasks or using heavy accessories, e.g., printers and privacy screens, the gas spring is up to the job.

Alongside exemplary ergonomics, this range also boasts clear, aesthetic lines. State-of-the-art features, such as wireless charging, make the *temptation c* one of the leading table systems in its class.

# Always the ideal solution for ... seated workplaces

Technology

Telescopic height adjustment or ratchet height adjustment without the need for tools

Crank-operated height adjustment

Recommended for

permanently designated seated workplaces

Seated workplaces as multi-user workstations

Height adjustment range

620 - 850 mm

620 - 850 mm

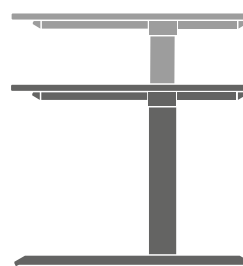
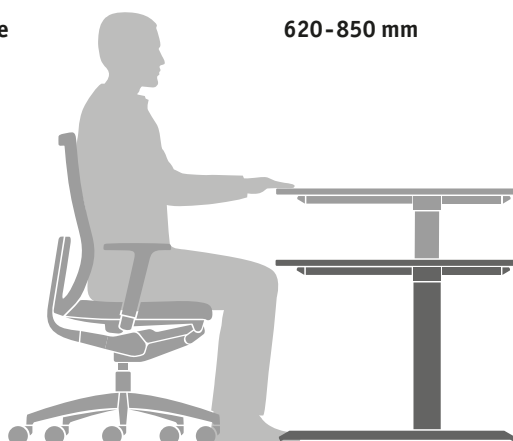

Product name

temptation c

temptation c

Six different versions of height adjustment are available for the *temptation c*; three of which are for seated heights and three for both seated and standing heights. Regardless of which technology you opt for, you will be choosing perfected ergonomics together with unparalleled flexibility.

**Height adjustment using tools.** Manually adjustable. Benefit: the most cost-effective solution for height adjustment.

**Height adjustment without tools.** Using a simple 10 mm ratchet setting, this option is extremely user-friendly. Benefit: quick, individual adjustment.



**Crank-operated height adjustment.** For multi-user workstations, as found in call centres and desk sharing stations. Benefits: simple adjustment, no power connection required.



# ... seated/standing workstations

Motorised height adjustment, including sensor disconnection

Seated/standing workstations as multi-user stations – particularly suited for special configurations

650 - 1250 mm

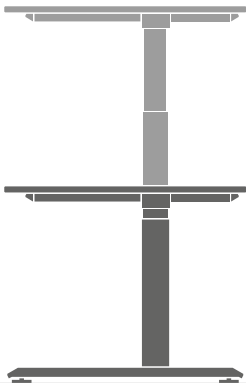

temptation ci

Motorised height adjustment, including sensor disconnection

Seated/standing workstations as multi-user stations – featuring state-of-the-art sensor technology

650 - 1280 mm

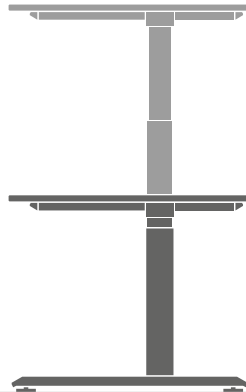

temptation c smart

Gas spring with manual load setting

Seated/standing workstations as multi-user stations – with rapid, intuitive operation, not dependent on a power source

680 - 1180 mm

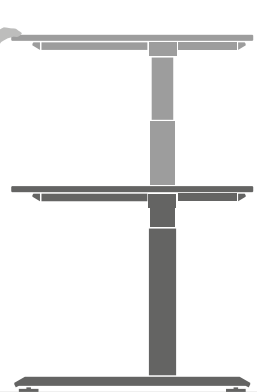

temptation c get up



**Electric motor height adjustment** with “Up/Down” control element or, optionally, with a digital display and memory function for four preselected heights. Benefits: weight-independent operation, simple adjustment with a power supply, sensor disconnection for sensitive impact protection, low noise generation. The “Up/Down” control element recessed in the desktop is available as an option. As well as providing a clear and modern look, this also makes operation even more intuitive.



**Safety as standard.** The sensor disconnection monitors the height adjustment of the desktop. In the event of jarring or slight imbalances, adjustment is immediately stopped.



**Gas spring height adjustment.** Ideal force adjustment using the crank handle for individual setting of the table’s live load of up to +50 kg. Benefits: fast and intuitive adjustment, not dependent on power sources, no costs for stand-by mode and maintenance, no CO<sub>2</sub> emissions due to currentless operation, low noise generation.



## Here's to good collaboration.

Together with other Sedus products, *temptation c* offers a wide range of options for customised workplace and room designs. For example, the privacy elements from *se:wall* can also be attached behind a height-adjustable table in order to separate quiet workstations from more lively ones – and these are available in freely selectable working heights. Tall pedestals or Sedus *grand slam z* also provide additional storage space which simultaneously act as a room divider, privacy screen or contact point for brief meetings held whilst standing.



**System adapter.** It accommodates lights, privacy elements and function bridges to name a few of its uses.



**Complementary.** The central organisation rail from *se:wall* provides plenty of room for practical accessories. This also includes the option of a power supply via a socket and USB charger.



**Practical.** The printer shelf, laptop holder and PC housing holder located within easy reach allow individual desks to be customised.





## Being organised is half the battle. So you don't lose sight of what matters.

The saying goes that the state of a desk reflects the state of the mind. Sedus *temptation c* features a clear electrical connection concept. All the cables are elegantly concealed in the electrical connection flaps. As the flaps can be easily accessed from above, connecting personal technical equipment is no longer an issue.





**A free table.** The sliding top allows direct access to the cable tray below the desk. A fixed table top can be fitted with a fold-up cable tray. At the desk, the cables are either guided through the panel on the side or through the cable management system. There is also an elegant round grommet and a handy table-top socket. This makes for an orderly desk.



**Elegant.** Functional and aesthetically pleasing: the continuous and two-part electrical connection flap renders the cable tray invisible yet still allows easy and convenient access to power and data connections as and when needed. The brushes make it possible to supply cables to any point.

**Unobserved.** The knee screen made of plexiglass, melamine or real wood veneer protects from prying eyes.



**Networker.** The flush-mounted socket and induction surface for the wireless charging of smartphones offer additional power supply options.

# Flexibility is in the family.

All the tables within the *temptation* family can be harmoniously combined. The ergonomic C-frame tables from *temptation c* work alongside the 4-leg tables from *temptation four*, for example, as work and conference solutions. Thanks to the uniform design, *temptation twin*, *high desk* and *prime* also dovetail seamlessly into the overall look.

The attractive design of the *temptation c* desktop and frame components are guaranteed to enhance the appearance of every room. With numerous attachment and linking elements, the tables can be configured to suit your requirements. This makes it not only economical but also future-proof.

**Inviting.** A separate meeting table is no longer required; the curve of the table offers enough space and immediately creates an intimate meeting atmosphere.



**Generous.** The double desk with side return provides a primary worksurface to the front whilst the side of the desk can be used as additional storage space.



# Perfect for a good communication style.

The conference tables in the *temptation c* product family are characterised by intelligent functionality and efficiency. Various desktops are available in several sizes, materials and colours. This allows you to create attractive meeting situations to suit all needs and rooms.



## Consistent design.

The look and finish match the desks.



**The more the merrier.** The large boat shape can accommodate up to ten people at a table.



**A perfect fit.** We also have ideal solutions for smaller meeting rooms.



**Communicative.** The trapezoidal shape is ideal for using the *monitor caddy*, for example, in training sessions and videoconferences.



**Desks**

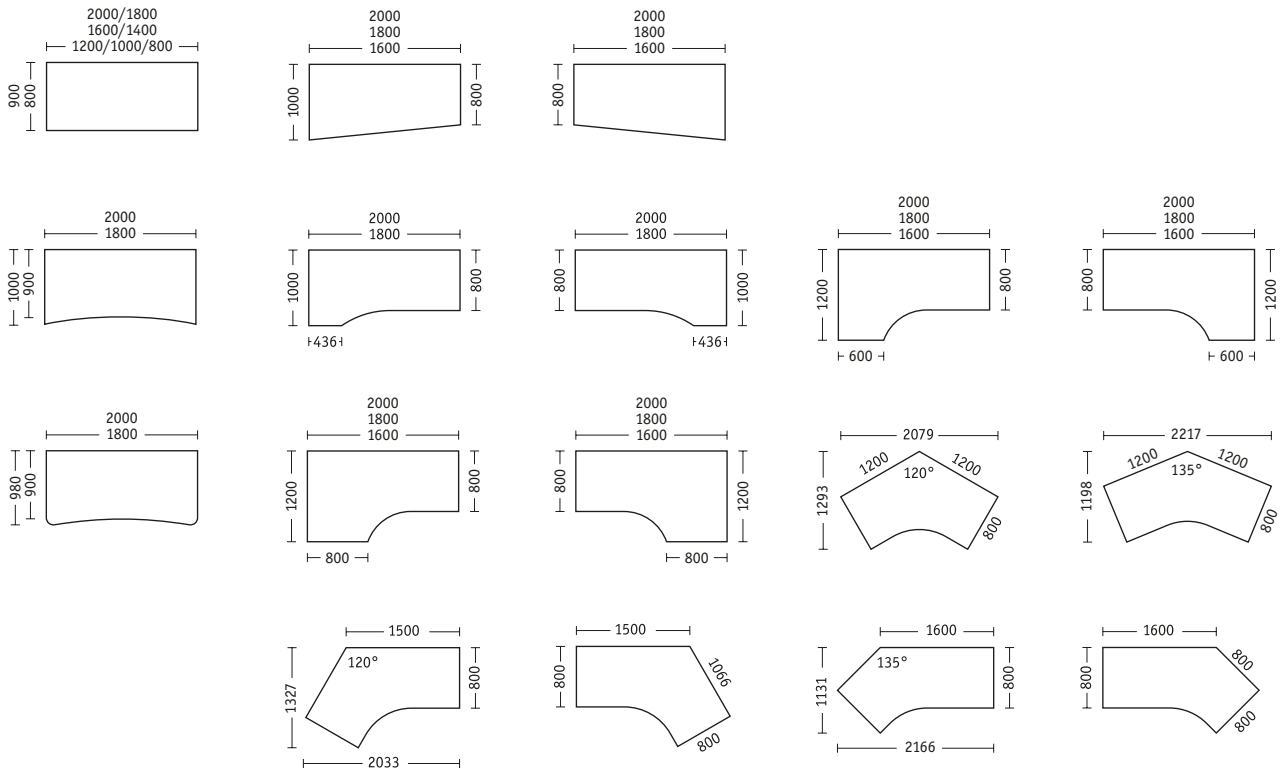

**Returntables**

**Extension shelf**

**Side tables**

**Linear desks**

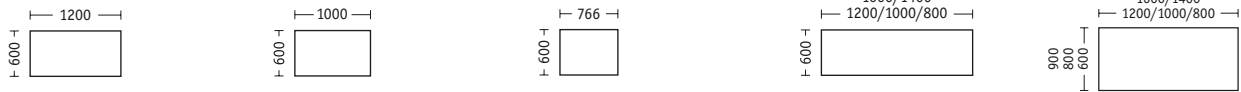

**Add-ons**

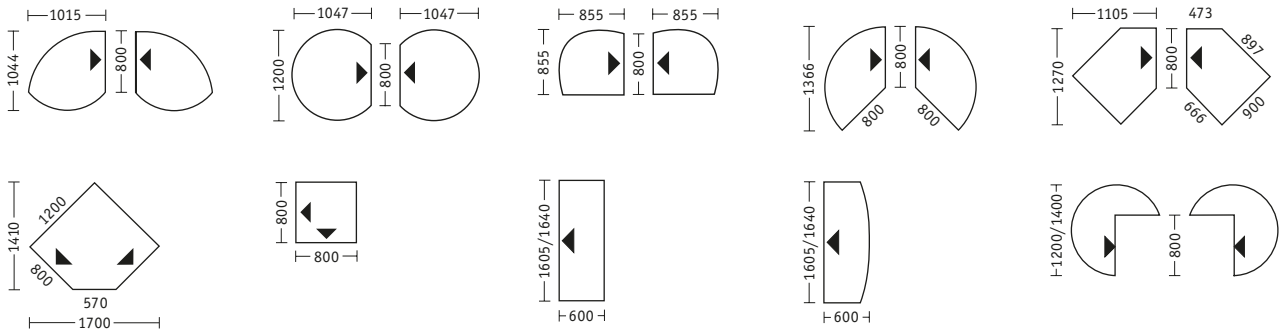

**Conference tables**

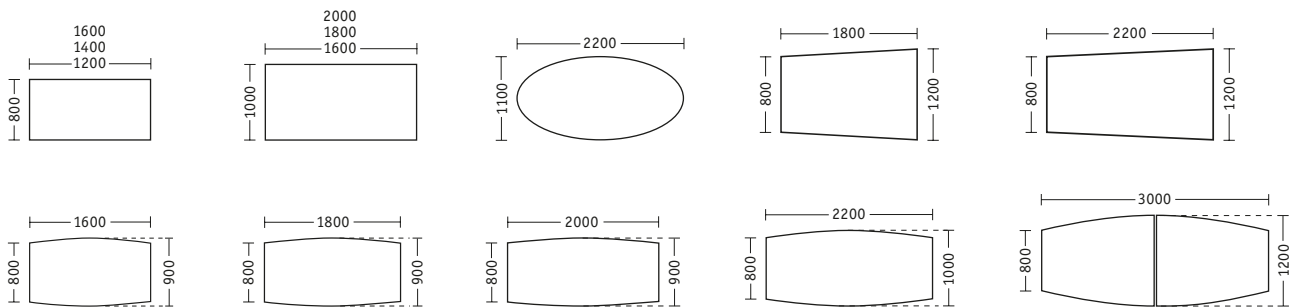

Dimensions in mm

**Veneers**



**C11** Oak natural



**C17** Oak wenge varnish



**C19** Rustic beam oak light



**C20** Rustic beam oak dark



**D14** Walnut smooth



**D15** Walnut wild



**D16** Walnut rustic

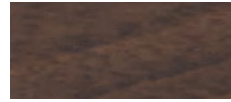

**D11** Walnut dark



**E41** Ash natural



**E10** Ash white



**E45** Ash black



**B26** Beech natural



**H11** Maple natural



**H12** Heartwood maple natural



**U10** Elm natural



**Q10** Hickory natural

**Melamine**



**K80** Ash light



**K81** Oak light



**K82** Oak natural



**K83** Oak cognac



**K84** Walnut natural

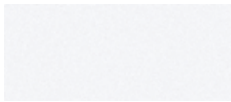

**A14** pure white



**K74** natural white

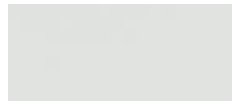

**O2** arctic white



**K70** graphite black



**K77** light grey



**K78** pebble grey



**K79** stone grey



**N10 likewood** Oak natural



**N11 likewood** Oak lime washed

**Side panels**



**120** white



**119** white aluminium



**24** black

**Modesty panels / desk screens plexiglass**

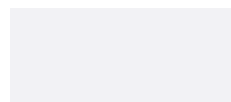

**105** translucent white



**122** kiwi (only modesty panel)

**Foot supports**



**120** white



**119** white aluminium



**24** black



**236** chrome-plated

**3rd level**

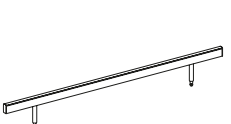

Function bridge

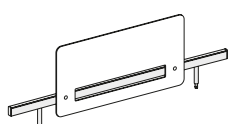

Plexiglass modesty screen



Flower vase



Cup holder



Storage tray DIN A4 portrait

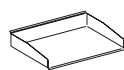

Storage tray DIN A4 landscape

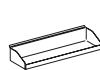

Pen tray landscape



Pen box



Notelet box for 90 x 90 mm

# Sustainability down to the last detail.

Sustainability and “Made in Germany” quality have been key company principles at Sedus for more than 50 years. Principles that Sedus *temptation c* also embodies and which are reflected in recycling-orientated product design, ecologically tested materials, resource and energy-conscious manufacturing and ongoing quality tests. As an example, in the manufacture of the *temptation c* veneered table tops, only selected woods from sustainable forestry, such as beech, ash and oak, are used. Ultramodern, energy-saving and environmentally friendly production of the steel and aluminium components is also part of the quality and sustainability philosophy of Sedus. More information is available at [www.sedus.com](http://www.sedus.com)





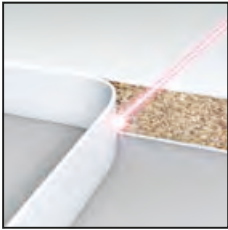

**Innovative laser edge.**  
Jointless edge processing at the highest level that harmoniously combines durability, beauty and environmental friendliness.



**Sustainable and close.**  
Real wood veneers from regional and sustainable forestry are not only fascinatingly beautiful, but also save transport kilometres.



**Gentle protection.** Instead of lacquer coating, Sedus relies on more environmentally friendly powder coating for finishing and to protect against rust.

Sedus operates globally in accordance with the principles of the UN Global Compact on human rights, labour standards, environmental protection and fighting corruption.



**Company:**



**Sedus temptation c:**



# sedus

[www.sedus.com](http://www.sedus.com)