

mooia

sedus



# Space for creative freedom

Ground-breaking concepts and solutions which open up a whole new world of possibilities when it comes to high-class interior design: mooia creates imagery which is made distinct with your personal designs. For unmistakable interiors.

Yet mooia doesn't just stop there. The integrated and invisible sound absorbers offer a highly effective solution to acoustic problems. Whether as an image on a wall, a panel on the ceiling or a free-standing wall system, mooia offers first-class aesthetics and soundproofing.





## There are many acoustic solutions, but only few stand out from the crowd.

Why can't aesthetics and soundproofing go hand in hand? The aim was to develop a flexible solution which could be used to reduce the noise level as required without having to compromise in terms of individual design: the result goes by the name of mooia acoustic.

Perfect room acoustics can also look perfect. With mooia acoustic effectively reducing noise and echo couldn't be easier. All elements can be flexibly combined with one another and imprinted in high-resolution quality. mooia acoustic – acoustic solutions at their most attractive.

With mooia acoustic the sound-absorbing core is hidden behind a textile skin which can be designed any way you wish. The mooia acoustic elements blend seamlessly into the interior design concept, just like high-quality pieces of furniture. All products as tested in accordance with DIN EN ISO 354.

mooia acoustic impresses with its simple handling, exemplary quality of workmanship and exclusive design.

In the "Innovationspreis Textil und Objekt 2008" competition, the renowned architecture magazine, AIT, described mooia acoustic as a very valuable contribution in terms of sound absorption in large rooms.



# Good acoustics are essential for a pleasant atmosphere

Just like temperature and light, acoustics are responsible for determining whether the atmosphere in a room is regarded as pleasant or not. Acoustics determine performance, creativity and well-being wherever people spend time. Reason enough to invest in a professional sound absorption system – with mooia acoustic.

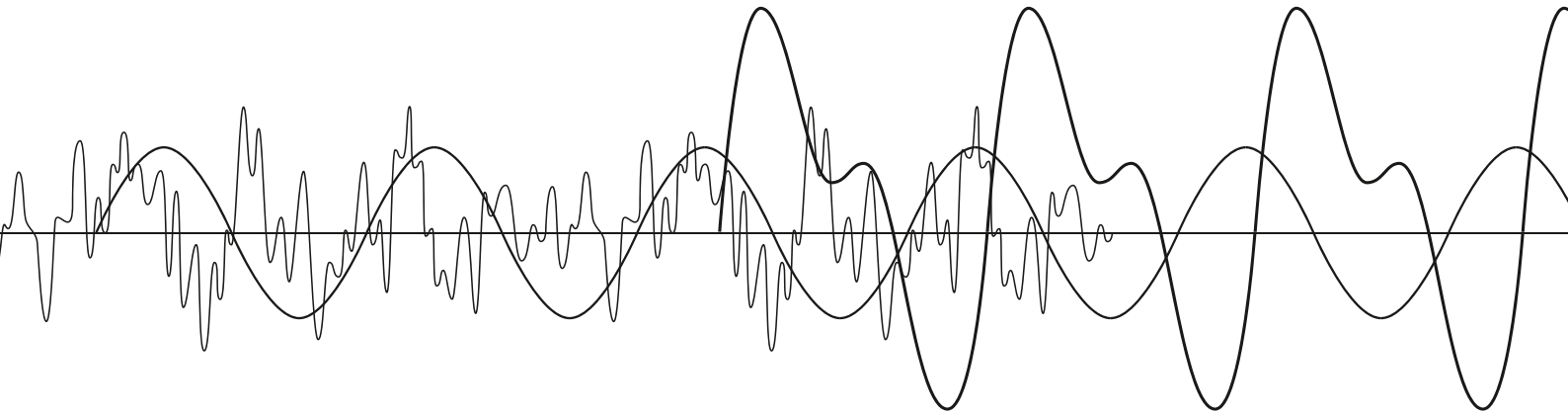

**Tinkling | Rattling | Babble of voices | Footsteps | Noise from outside ...**

## mooia acoustic

The mooia acoustic products are designed to be variable in order to guarantee maximum creative freedom. The elements can be attached to the wall or ceiling or, indeed, positioned freely in the room as required.



# Structural design

The mooia acoustic product range embodies the unity of perfect room acoustics and aesthetics. Each element comprises three components: the frame structure made of light-weight aluminium, the textile skin on both sides which can be freely customised and the sound-absorbing core. What makes the frame section particularly special is the continuous groove which can accept various connectors in order to enable the most diverse configurations.

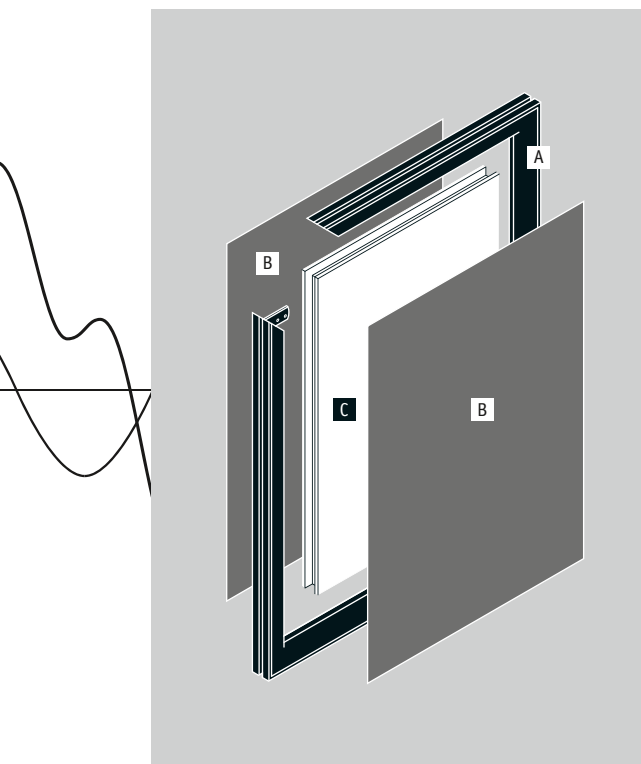

**A Construction:** The frame section is made of high-quality aluminium.

**B Design:** Any design can be selected for the textile skin and then printed in brilliant digital quality.

**C Acoustics:** The sound-absorbing core is made of a melamine resin foam.

- 1 Thanks to the piping, the textile skins can be quickly attached and changed.
- 2 The sound-absorbing core is tailored to the frame section.
- 3 The continuous groove in the frame section enables connectors to be attached and several elements to be combined.



# mooia acoustic wall

mooia acoustic walls are decorative, large-sized images which also help improve the acoustics in a room. Sound reverberation is reduced in the long term and the acoustic function of the image remains invisible. mooia acoustic wall turns room acoustics into an eye-catching work of art. The wall comes in 11 standard heights and 8 standard widths.



**mooia acoustic wall**  
**Example 1**

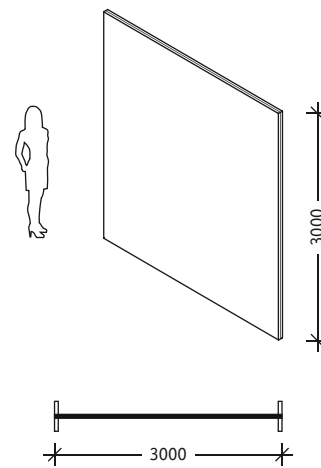

**mooia acoustic wall**  
**Example 2**

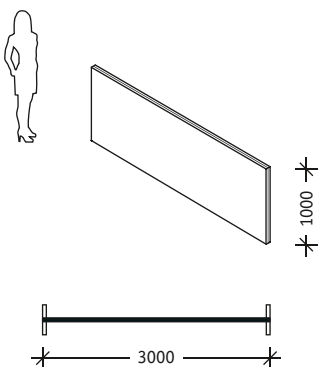

**mooia acoustic wall**  
**Example 3**

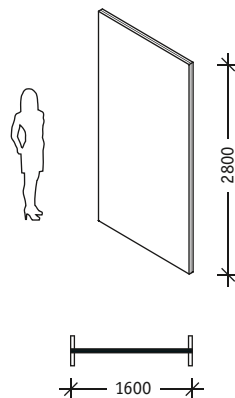



moia acoustic wall is the professional solution for first-class acoustics. Also available in larger sizes of up to five metres.

# moovia acoustic base

**moovia acoustic base** is ideal for dividing up offices: The freely configurable elements create working areas with a pleasant atmosphere and reduced noise levels whilst, at the same time, preserving eye contact and the exchange of information.

**moovia acoustic base** creates islands of calm away from the hustle and bustle of office life. This type of acoustic shielding is ideal for facilitating concentrated work and confidential conversations.

**moovia acoustic base** provides for pleasant and quiet private spaces in large rooms. The elements measuring 1873 mm in height are particularly effective at absorbing sound due to their large surface area and can be systematically extended with further moovia acoustic products.

1148, 1498, and 1873 are the final sizes (including 9 mm base) and correspond perfectly with the heights of the Sedus storage unit system. In addition there are three standard heights 1200, 1600 and 2000 (plus 9 mm base).

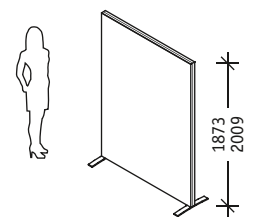
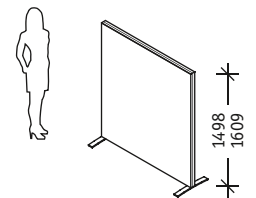
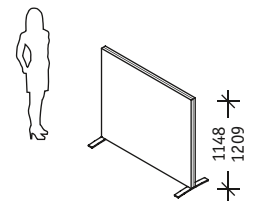

**moovia acoustic base** is available in the widths 800, 900, 1000, 1200, 1600, 1800 and 2000 mm.







**mooia regular base**  
frame section with  
textile skin, without  
acoustic core as a  
transparent screen.

# Configurations

mooia acoustic base creates almost endless scope for customised interior design. All the elements can be combined using steel connectors in order to divide up rooms both acoustically and visually. Angled, straight, cross- and T-shaped connectors open up a wealth of possibilities for designing rooms.

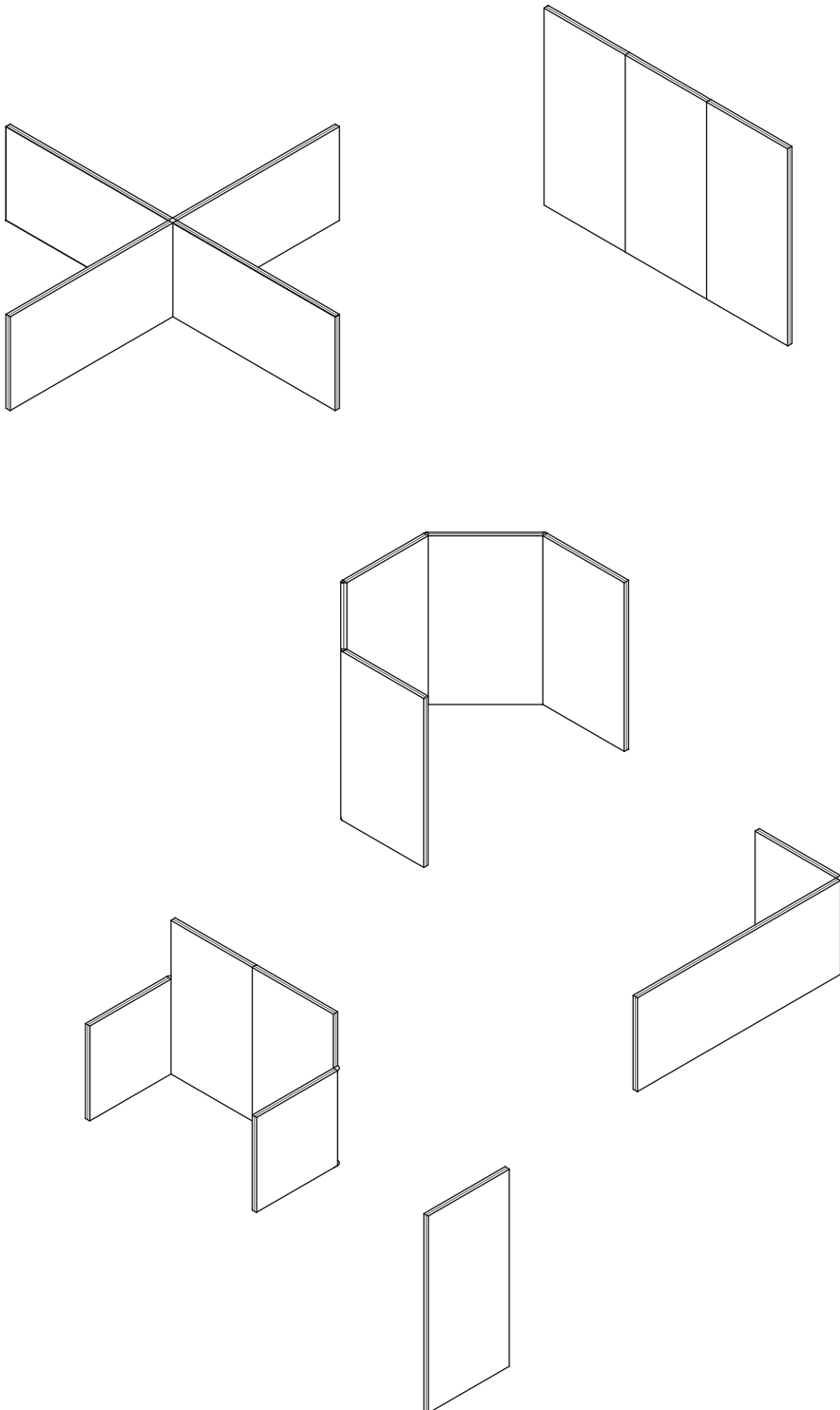

**180° connector**

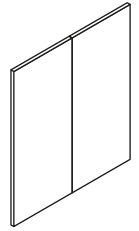
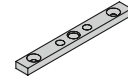

**T-shaped connector**

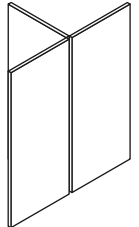
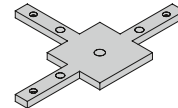

**X connector**

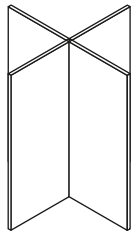
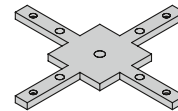

**135° connector**

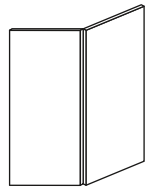
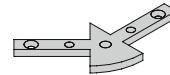

**120° connector**

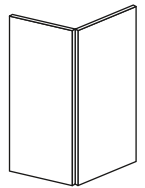
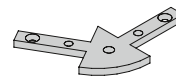

**90° connector**

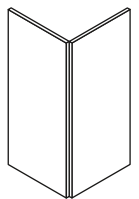
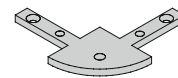

**90° connector, angled**

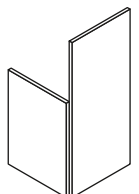
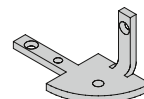

# mooia acoustic air

mooia acoustic air reduces the echo time and lessens sound reverberation from the ceiling. This element can be used on its own or in conjunction with the mooia acoustic base and mooia acoustic wall in order to increase the effectiveness thereof. mooia acoustic air can be attached any distance from the ceiling.

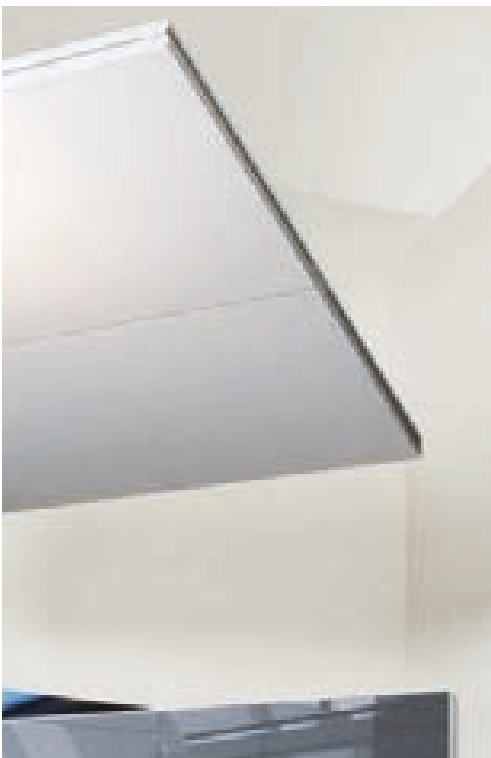

**mooia acoustic air**

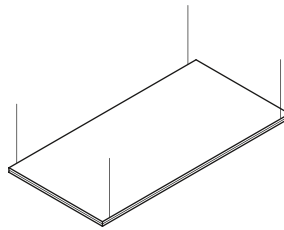

**mooia acoustic air with connector set**

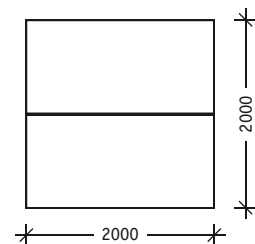
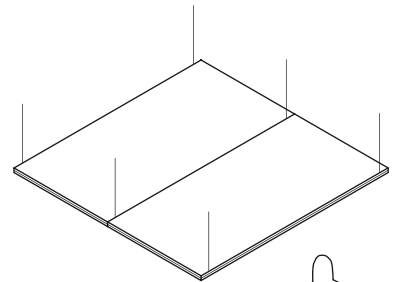

# mooia versions

	<b>mooia acoustic wall</b>	<b>mooia regular wall</b>	<b>mooia acoustic base</b>	<b>mooia regular base</b>	<b>mooia acoustic air</b>
<b>Acoustic function</b> with sound-absorbing function	yes	no	yes	no	yes
<b>Heights (mm)</b> (base plus 9 mm foot) <b>x</b> <b>Widths (mm)</b>	<b>1000/1200/1400/1600/1800/2000/ 2200/2400/2600/2800/3000</b> <b>x</b> <i>1600/1800/2000/2200/2400/2600/ 2800/3000</i>		<b>1139/1200 x</b> <i>800/900/1000/1200/1600/1800/2000</i> <b>1489/1600 x</b> <i>800/900/1000/1200/1600/1800</i> <b>1864 x 800/900/1000/1200</b> <b>2000 x 1000/1200</b>		2000 (length)  1000
<b>Depth/Thickness (mm)</b>	52.4		52.4		52.4
<b>Base (L/W/H)</b>			400/60/8 or 500/100/8		
<b>Changeable fabric</b>	yes		yes		yes
<b>Textile skin</b> unprinted, solid colours	arco (4 colours) novo (3 colours)		arco (4 colours) novo (3 colours)		TCS-300 (white)
<b>Textile skin</b> printed, opaque	TCS-300		TCS-300		
<b>Textile skin</b> printed, transparent				flag 110 voile CS	

## mooia design options

Thanks to the various design options, Sedus mooia can be used as an image bearer, guidance system or as an interchangeable advertising space. (Almost) anything is possible.

You can choose from the large selection of online images in two image databases.

And, of course, you can also select your own design, e.g. company logo, customised shade or a photo of your choice. The image is transferred to white, opaque base material (TCS-300) in a digital high-end printing process.

mooia wall and mooia base can also be covered in an unprinted, solid-colour textile skin from the “arco” or “novo” collections. Furthermore, the two transparent fabrics (voile and flag) are also available for the mooia regular base.

The textile skins are easy to change and can thus be updated and replaced at any time.

# mooia textile skins



arco 6540 beige



novo 6541 beige



TCS-300 3000 white



arco 6559 light grey



novo 6554 light grey

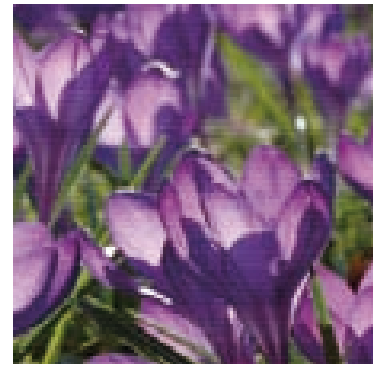

TCS-300 printed

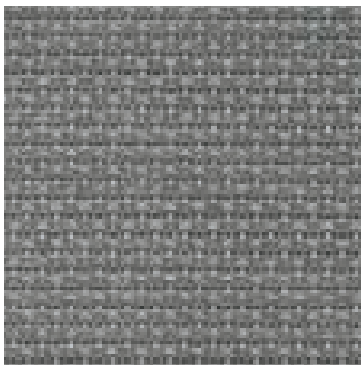

arco 6556 grey

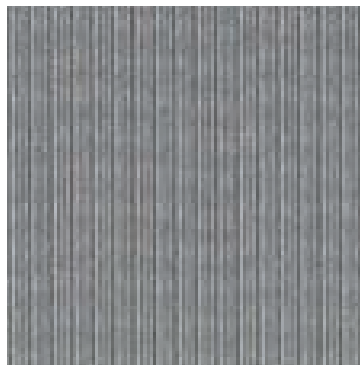

novo 6555 grey

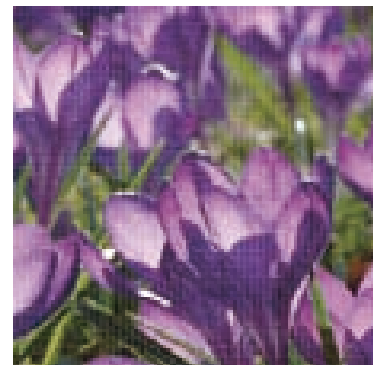

flag 110 printed

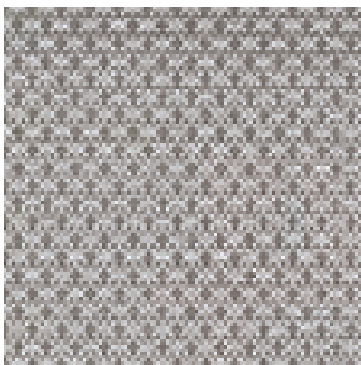

arco 4004 silver

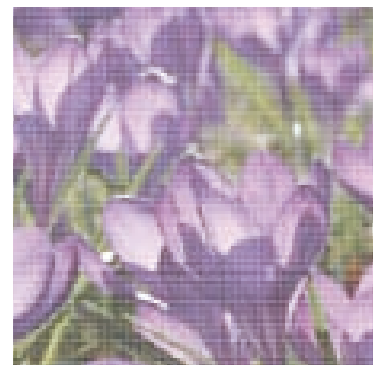

voile CS printed

# Find the perfect image in just a few clicks of the mouse

You will find a link to the 40 free images (picture database I) shown on this double page at [www.sedus.co.uk](http://www.sedus.co.uk) > Products > mooia.

There you will also find a link to picture database II where you can select the perfect picture on payment of a licence fee.

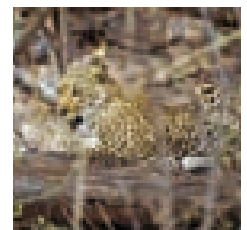
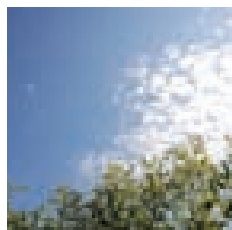
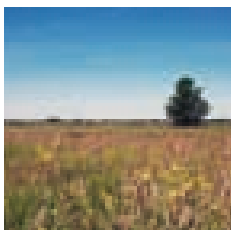
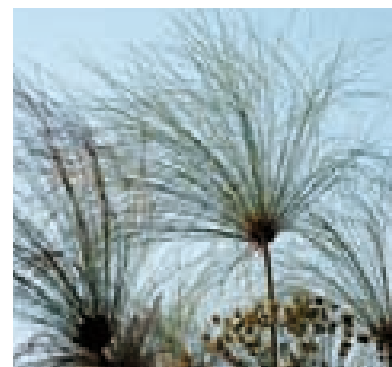
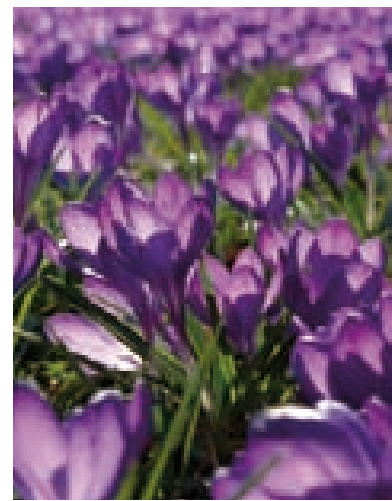

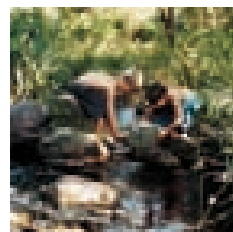
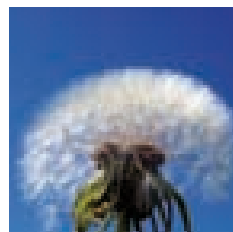
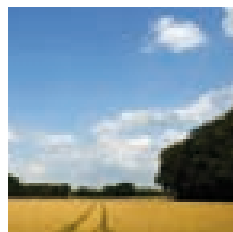
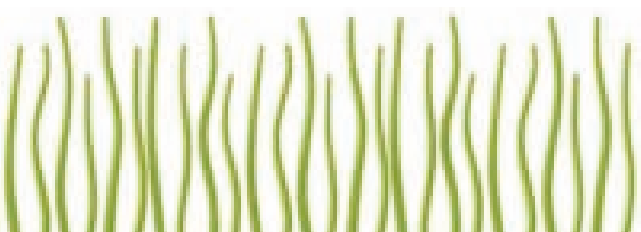
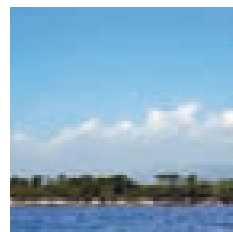
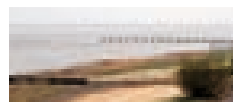
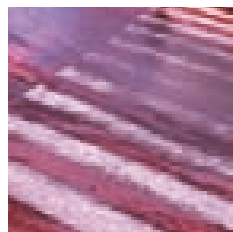
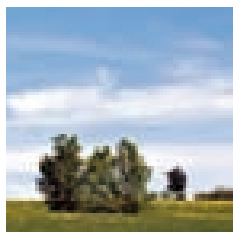
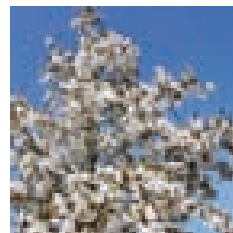
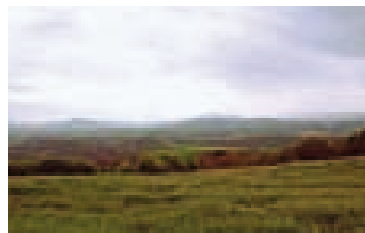
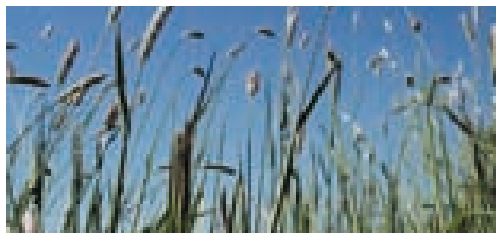
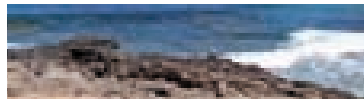
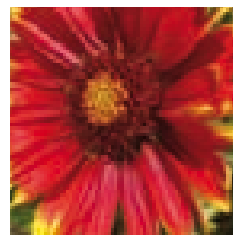
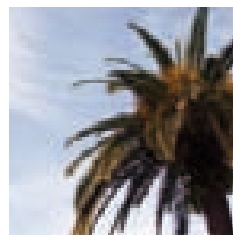
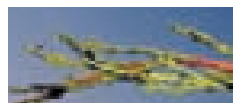
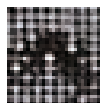
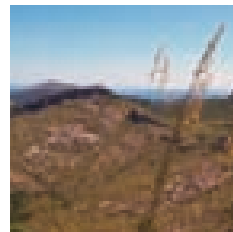
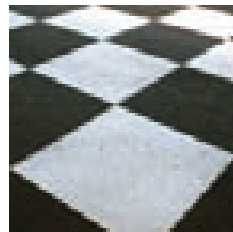
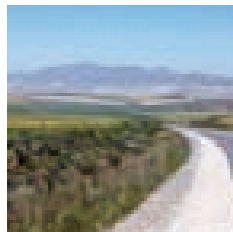
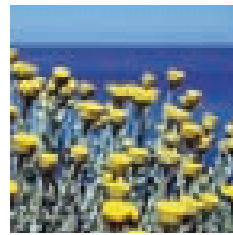
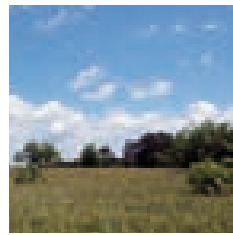
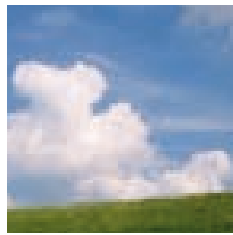

animals | architecture | background | beauty  
 business | fashion | flowers | food | health | industry  
 lifestyle | landscape | nature | people | science  
 sport | stills | technology | travel

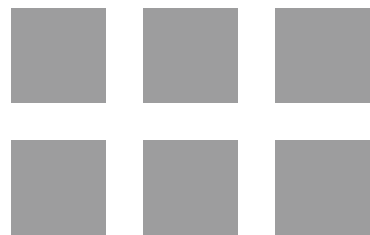



[www.sedus.com](http://www.sedus.com)